

DATA SHEET

CITILED Standard CL-375 Series

Tow-color Type

CL-375TD/SYG-D-TS



CONTENTS

1. Scope of Application	P	2
2. Part code	P	2
3. Outline drawing	P	3
4. Performance	P	3
5. Characteristic (Typical characteristics)	P	4
6. Reliability	P	5
7. Taping Specifications (in accordance with JIS standard)	P	6
8. Packing Specifications	P	7
9. Precautions	P	8
10. Designing precautions	P	9
11. How to use	P	10
12. Cleaning	P	10
13. Other precautions	P	11

CITIZEN ELECTRONICS CO., LTD.

1-23-1, Kamikurechi, Fujiyoshida-shi, Yamanashi, 403-0001, Japan Tel. +81-555-23-4121 <http://ce.citizen.co.jp>
Copyright © 2010 CITIZEN ELECTRONICS CO., LTD. All Right reserved.

1. Scope of Application

These specifications apply to chip type LED lamp, CITILED, model CL-375TD/SYG-D-TS

2. Part code

Product Nomenclature

CL - 375 - TD/SYG - D - TS
 [1] [2] [3] [4]



[1]	Series	:	Tow-color side-lighting LED
[2]	Lighting color	:	TD Top high brightness orange SYG Super brightness yellow green
[3]	Diffusion	:	D Colored Diffused
[4]	Shipping mode	:	TS Taping (standard) Non-coded Bulk

3. Outline drawing

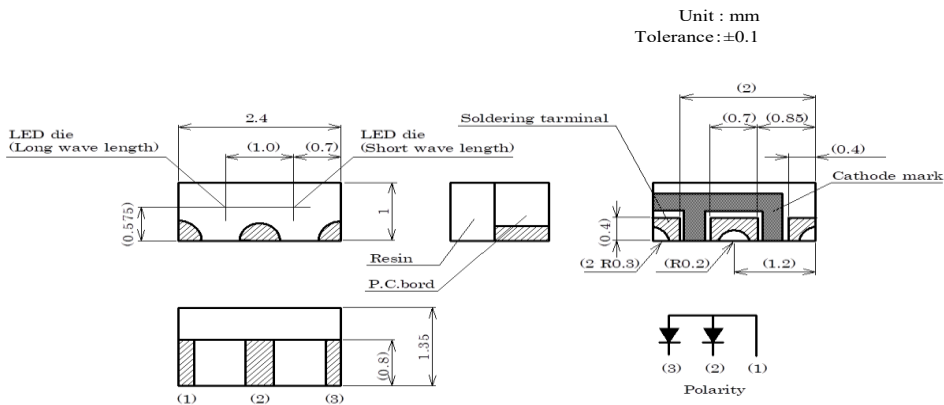

※ Dimensions in parentheses are reference values.

4. Performance

4-1. Absolute Maximum Rating

Parameter	Symbol	Rating	Rating
Total Value of Power Dissipation	P^{*1}	110	mW
Power Dissipation	P_d	78.0	mW
Forward Current	I_F	30.0	mA
Forward Pulse Current	I_{FP}	100 ^{*2}	mA
Reverse Voltage	V_R	TD:4 SYG:5	V
Operating Temperature	T_{OP}	-25 ~ +80	°C
Storage Temperature	T_{ST}	-30 ~ +85	°C

*¹ P means the Total Value of Power Dissipation when both colors are ON.

*² Duty < 1/10, Pulse width < 0.1 msec

4-2. Electro-optical Characteristic

(Ta=25°C)

Parameter	Symbol	Condition	Color	Min.	Typ.	Max.	Unit
Forward Voltage	V_F	$I_F=20mA$	TD	—	2.1	2.6	V
			SYG	—	2.2	2.6	
Reverse Current	I_R	$V_R=5V$	TD	—	—	100	μA
			SYG	—	—	100	
Luminous Intensity	I_v	$I_F=20mA$	TD	16	60	—	mcd
			SYG	20	58	—	
Dominant Wave length	λ_d	$I_F=20mA$	TD	—	605	—	μm
			SYG	—	575	—	
Spectrum width of half value	$\Delta\lambda$	$I_F=20mA$	TD	—	(20)	—	μm
			SYG	—	(12)	—	

Note 1) The measurement tolerance of forward voltage is ±3% at our tester.

Note 2) The measurement tolerance of luminous intensity is ±10% at our tester.

Note 3) The measurement tolerance of dominant wavelength is 2 nm at our tester.

Note 4) Please be aware that the above electro-optical characteristics are achieved when applying the current values shown in the table.

Please consult us when this product is used under any other conditions.

5. Characteristic (Typical characteristics)

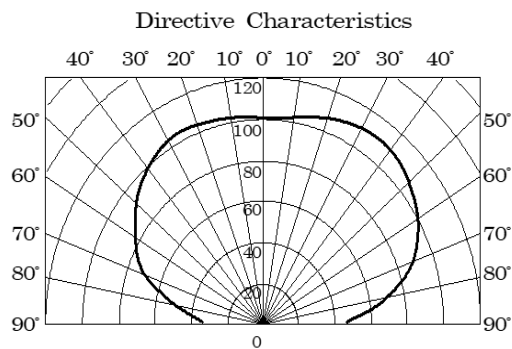
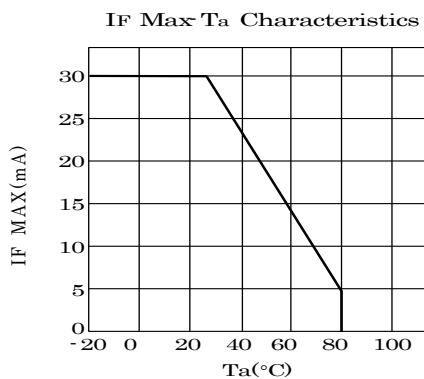
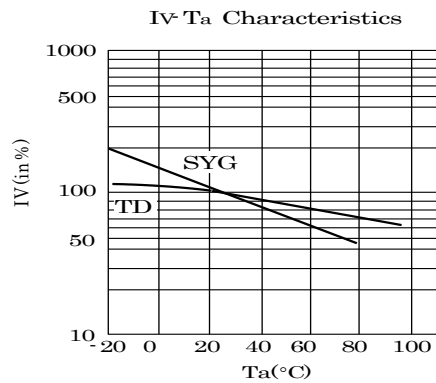
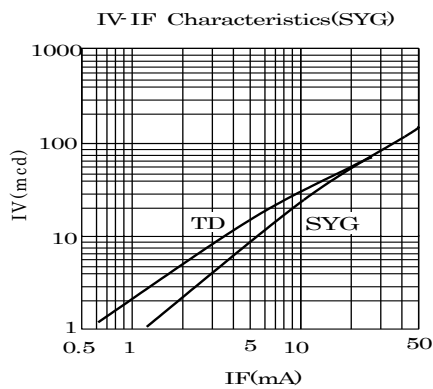
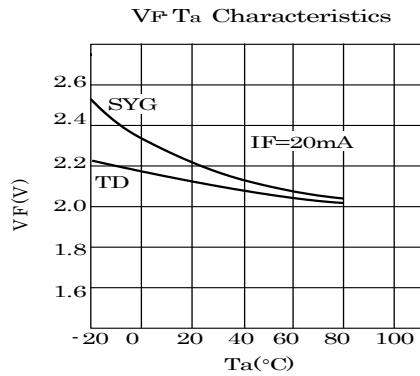
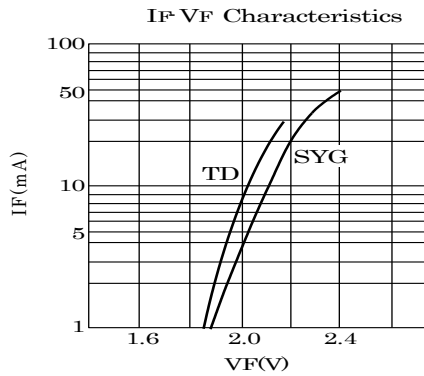

6. Reliability

6-1. Details of the tests

Test Item	Test Condition
Life Test in Continuous Operation	25 ± 3 °C, maximum rated value $\times 500$ $\begin{matrix} +24 \\ -12 \end{matrix}$ hours
Low Temperature Storage Test	-30 $\begin{matrix} +3 \\ -5 \end{matrix}$ °C $\times 500$ $\begin{matrix} +24 \\ -12 \end{matrix}$ hours
High Temperature Storage Test	85 $\begin{matrix} +3 \\ -5 \end{matrix}$ °C $\times 500$ $\begin{matrix} +24 \\ -12 \end{matrix}$ hours
Moisture-proof Test	60 ± 2 °C, 90 ± 5 %RH for 500 $\begin{matrix} +24 \\ -12 \end{matrix}$ hours
Thermal Shock Test	-30 °C $\times 30$ minutes ~ 85 °C $\times 30$ minutes, 5- cycle
Solder Heat Resistance Test	Recommended temperature profile (reflow soldering) $\times 2$, (2nd test must be started after the samples are stabilized thermally.)

6-2. Judgment Criteria of Failure for Reliability Test

Measuring Item	Symbol	Measuring Condition	Failure Criteria
Forward Voltage	V _f	I _F =20mA	>U $\times 1.2$
Reverse Current	I _R	TD V _R =5V	>U $\times 2$
		SYG V _R =4V	
Luminous Intensity	I _v	I _F =20mA	<S $\times 0.5$

U means the upper limit of the specified characteristics.

S means the initial value.

Note : Measurement shall be taken between 2 hours and 24 hours, having returned the test pieces to the normal ambient conditions after the completion of each test.

6-3. Influence with static electricity

This product is susceptible to accumulation of static electricity and surge voltage, which may decrease reliability or result in damage to LED dies.

7. Taping Specifications (in accordance with JIS standard)

7-1. Shape and Dimensions of Reel

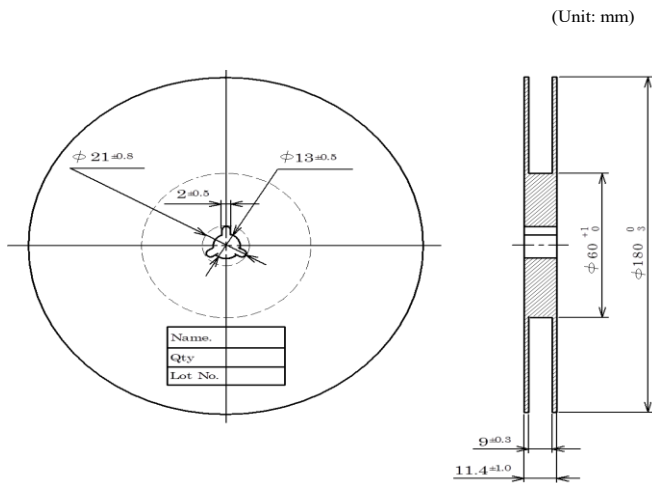

7-2. Dimensions of Tape

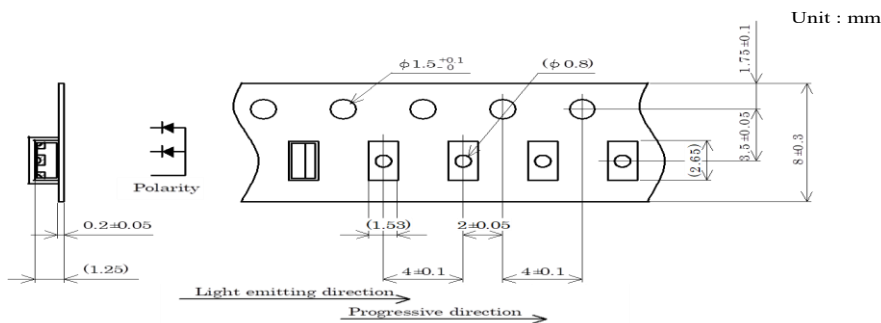

※ Dimensions in parentheses are reference values.

7-3. Configuration of Tape

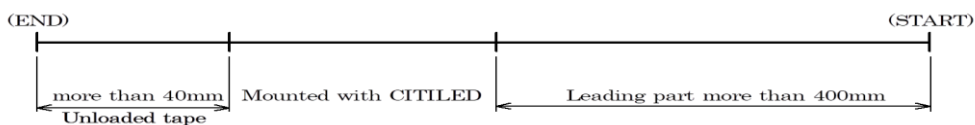

7-4. Quantity:3,000 pcs/reel

(Please note that the shipping quantity of this product may be less than 3000 pieces per reel (minimum quantity: 1000 pieces) depending on the shipping quantity, shipping delivery date and other conditions. However, in this case, we will notify you in advance.)

8. Packing Specifications

8-1. Moisture-proof Packing

To prevent moisture absorption during transportation and storage, reels are packed in aluminum envelopes.

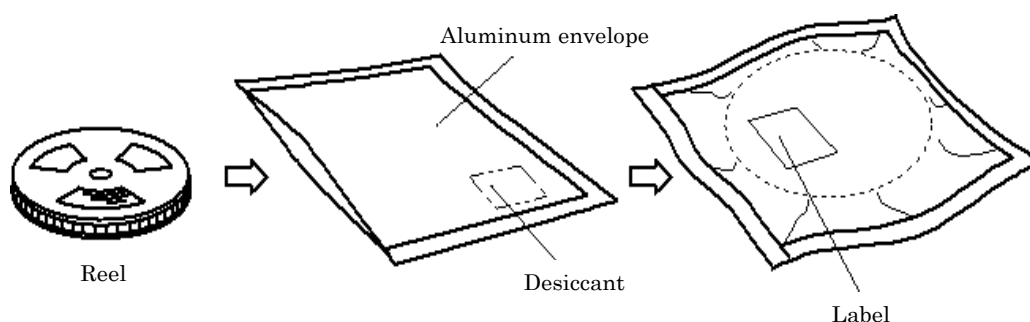

8-2. Storage

To prevent moisture absorption, it is strongly recommended that reels (in bulk or taped) should be stored in the dry box (or the desiccator) with a desiccant as the appropriate storage place. If not, the following is recommended.

Temperature: 5~30°C
Humidity: 60%RH max.

The devices should be mounted as soon as possible after unpacking. If you store the unpacked reels, please store them in the dry box or seal them into the envelope again.

8-3. Baking

After the storage period
(6 months in moisture proof packaging, or 7 days after unpacking moisture proof packaging), please bake the goods before use under the conditions described below.

Baking conditions: 60 °C × 12 hours or more (reeled one)
100 °C × 45 minutes or more (loose one)

Baking times: Up to one time

9. Precautions

9-1. Soldering

- (1) Manual soldering
 - 1) Solder of 96.5Sn 3Ag 0.5Cu is recommended.
 - 2) Bake the goods before manual soldering,
because otherwise it may cause resin to crack on account of moisture absorption.
 - 3) Use a soldering iron of 25W or smaller. Adjust the temperature of the soldering iron below 350°C.
 - 4) Force or stress must not be applied to the resin portion while soldering.
 - 5) Finish soldering within 3 seconds.
 - 6) Handle the devices only after temperature is cooled down.
- (2) Lead free soldering
 - 1) Following soldering paste is recommended
Melting temperature : 216 ~ 220°C
Composition : 96.5Sn 3Ag 0.5Cu
 - 2) The temperature profile at the top surface of the parts is recommended as shown below.
 - 3) It is requested that products should be handled after their temperature has dropped down to the normal room temperature.

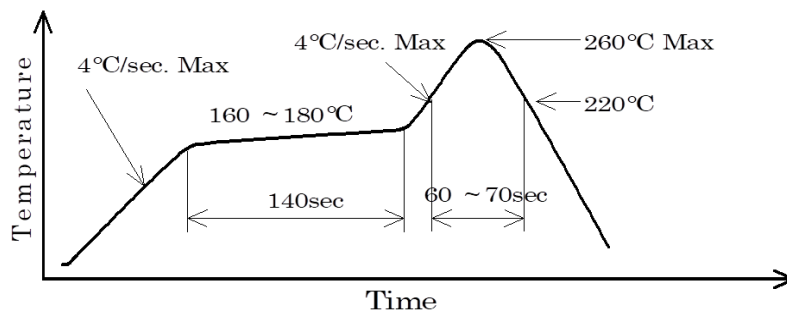

- (3) Caution
 - 1) Reflow soldering is allowed up to two times, and manual soldering up to one time.
 - 2) When conducting reflow twice, please shorten the interval between the first and second reflow to prevent moisture absorption.
Also, please cool (naturally) the product to the room temperature after the first reflow to start the second reflow.
 - 3) Make sure to avoid rapid cooling so that the temperature gradient from the peak temperature is gentle.
 - 4) Air reflow may cause an optical deterioration because of heat in the reflow and impact of atmosphere.
Nitrogen reflow is recommended.
 - 5) It is not recommended to repair the product after soldering.
 - 6) When soldering, please do not apply stress to LED while it is heated.

9-2. Handling precautions

- (1) Please avoid any stress added to the resin portion while it is heated.
- (2) Please avoid any friction by sharp metal nail etc. to the resin portion.
- (3) Please avoid handling the product with bare hands.
- (4) Please avoid applying any pressure to the product.
- (5) Please avoid stacking PCBs after mounting.
- (6) Please take countermeasures against static electricity to the same degree as those used for CMOS LSI.

10. Designing precautions

- (1) The current limiting resistor should be placed in the circuit so that is driven within its rating. Also avoid reverse voltage (over-current) applied instantaneously when ON or OFF.
- (2) When pulse driving current is applied, average current consumption should be within the rating. Also avoid reverse voltage applied when put off.
- (3) Recommended soldering pattern

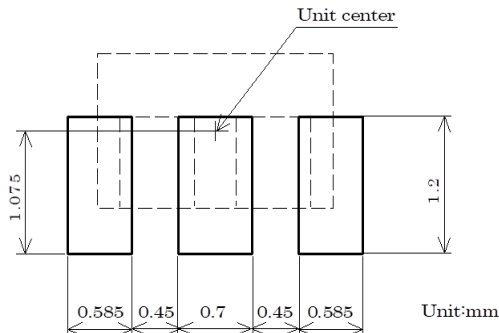

The above dimensions are not the one which guarantee the performance of mountability.

The use of the above pattern is recommended to use after deep study at your site

- ※ Recommended land pattern has only a land size on which LED can be mounted without problem. If mounting accuracy is required for a high-density mounting, please choose a land pattern that suits it.

- (4) When assembling the circuit board into the finished products, care must be taken to avoid the component parts from touching other parts.
- (5) When using multiple LEDs, it is required to connect a current limiting resistor on each path which the current flows to the LEDs.

(ex-1)

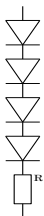

(ex-2)

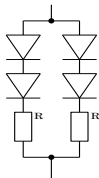

(ex-3)

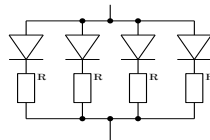

11. How to use

- (1) Please use forward current for the product.
Make sure that no forward or backward voltage is applied when it is not lighting.
Please avoid applying backward voltage continuously because it may cause migration and damage dice.
- (2) Please avoid applying excess voltage such as lighting surge to LED.
- (3) The service life may become shorter in areas where hydrogen sulfide is generated (such as near a hot spring or a volcano) or there is a lot of salt (such as near the coast).
- (4) Please consider generation of heat when using this product.

12. Cleaning

- (1) Please do not wipe LED.
- (2) A cleaning agent may damage the package and resin to cause malfunctioning.
Before use, make sure it will not affect the goods.
- (3) Ultrasonic cleansing is not recommended.

13. Other precautions

- (1) Warranty period is half a year from the day we delivered the product.
- (2) If any defect is found during the warranty period, do not disassemble or dismantle the product but contact our sales window to follow its instruction.
- (3) Do not reverse-engineer the product including disassemble or analyze without our approval.
- (4) The product is intended to be used for general electronic equipment such as general lighting, home appliances, and information-communication equipment.
It is not designed or manufactured to be used for special application
(eg. automobiles, trains, ships, airplanes, spaceships, submarine repeaters, atomic energy control systems, combustion equipment, life-support systems, safety devices).
We will not guarantee any application suitability for goods like those described above that require special quality and reliability.
In cases where the product is used in special applications and it causes an extensive property damage, threatens human life or damages the human body, we will not be held liable.
- (5) The product is not in conformity to ISO/TS16949 or intended to be used for in-vehicle application.
- (6) This specification will become void if it is not returned or if no purchase order is made within one year from the issued date.
- (7) We will not be liable for any disadvantage, damage or cause of legal action, or any other damage or loss that arise from the use or nonuse of technical information or data of this specification.
- (8) This technical information and data is provided for users as is, and Citizen Electronics Co., Ltd. does not guarantee that it is free from errors or defect in technical information and data, or this technical information and data conform to special applications, or this technical information and data does not infringe any rights of the user or third parties other than the user, or any other contents thereof.
- (9) Citizen Electronics Co., Ltd. reserves a right to modify technical information and data without notice.
- (10) When exporting our products, please ensure conformance with applicable laws and regulations and take appropriate actions such as obtaining an export license.
- (11) Please do not use or supply our products for any weapons of mass destruction (WMD) or for any other military purposes.
- (12) If we do not receive standing orders, we may recommend another product. If this product is to be used for a different model or for a succeeding model continuously, please contact our sales staff.
- (13) The contents of this document is not guaranteed because the specification and appearance of the product may change without notice for improvement.
Please exchange formal specifications with us when adopting the product for mass production.

The information described (text, photos, images) is subject to copyright and is protected by law. Unauthorized copying or reproduction without Citizen Electronics' approval is prohibited by law except for "reproduction for personal use" or "quotation," which is allowed by the Copyright Law.



is a trademark or registered trademark of Citizen Electronics Co., Ltd.

Leading the world's device technology

Products

- Lighting LED
- Chip LED
- Tactile switch



Application

- Mobile device
- Lighting device
- In-vehicle device
- Healthcare device
- Industrial device

· CITIZEN ELECTRONICS CO., LTD. shall not be liable for any disadvantages or damages resulting from the use of technical information or data included in this document of the impossibility of download and use, responsibility for the cause of lawsuit or any other damages or losses.

· This technical information or data shall be provided 'as is' to users and CITIZEN ELECTRONICS CO., LTD. does not guarantee the absence of error or other defects in this technical information or data, conformance of this technical information or data to specific purpose, this technical information or data of its use will not infringe the rights of users or third parties or any other content.

· CITIZEN ELECTRONICS CO., LTD. reserves the right to make changes to technical information or data without notification.

Information contained in this document such as sentences, photographs and images is subject to copyright, and is protected by law. Unless it is for "duplication for private use" or "quotation" under copyright law, any duplication or diversion of this information without permission of CITIZEN ELECTRONICS CO.,LTD. is prohibited by law.

CITILED is a registered trademark of Citizen Watch Co., Ltd.

CITIZEN ELECTRONICS CO., LTD.

1-23-1, Kamikurechi, Fujiyoshida-shi, Yamanashi, 403-0001, Japan
Tel. +81-555-23-4121
<http://ce.citizen.co.jp>

Requests / Inquiries

cej-inquiry@ml.citizen.co.jp

Website for LEDs for lighting

http://ce.citizen.co.jp/lighting_led/jp/