

DATA SHEET

1/14

1. Scope of Application

This data sheet is applied to the LED package, model CLL130-0101C1-28GV1J4 .

2. Part code

CLL 130 - 01 01 C1 - 28 G V1 J4
[1] [2] [3] [4] [5] [6]

[1] Part Code

[2] Dies in series quantity 1

[3] Dies in parallel quantity 1

[4] Correlated color temperature Warm Plus2

[5] Chromaticity range Vivid

[6] CRI Ra 95typ

< Features >

- External Dimensions 2.0 x 1.6 x 0.75
- Internal Structure: Chip LED Type

- Luminous Flux: 19.8 lm @ 65 mA
- CCT: Warm Plus2 (Vivid)
- CRI: Ra 95typ
- Thermal Resistance: 40 C/W

- RoHS Compliant

Symbol	CITLED
Name	CLL130-0101C1-28GV1J4
CITIZEN ELECTRONICS CO.,LTD. JAPAN	

3. Outline drawing

Unit : mm
Tolerances unless otherwise specified : +/-0.1

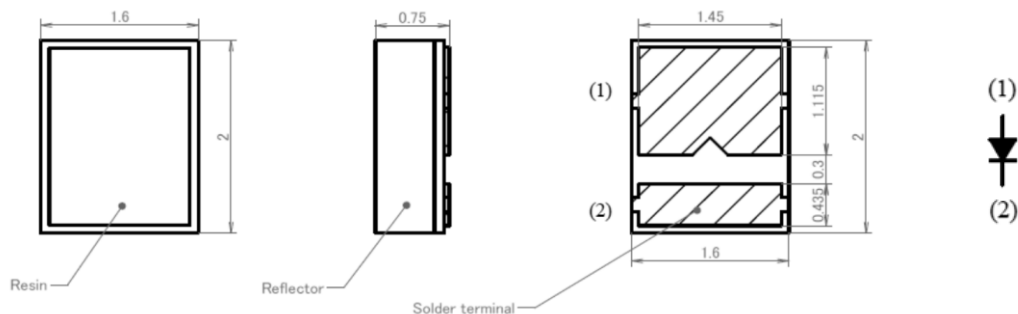

4. Performance

(1) Absolute Maximum Rating

Parameter	Symbol	Rating Value	Unit
Input Power	P_i	0.289	W
Forward Current	I_F	85	mA
Minimum current	$I_F \text{ min}$	5	mA
Reverse Voltage	V_R	5	V
Operating Temperature	T_{op}	-30 ~ +85	C
Storage Temperature	T_{st}	-40 ~ +100	C
Junction Temperature	T_j	120	C

*1 Input power and forward current are the values when the LED is used within the range of the derating curve in this data sheet.

*2 Refer to 3. Outline drawing for T_c measurement point

*3 D.C. Current : $T_j = T_s + R_j \cdot I_F$

* T_s : Solder terminal (Anode) temperature.

Symbol	CITLED
Name	CLL130-0101C1-28GV1J4
CITIZEN ELECTRONICS CO.,LTD. JAPAN	

DATA SHEET

3/14

4. Performance

(2) Electro-optical Characteristics

Ts=25C

Parameter	Symbol	Condition	Min.	Typ.	Max.	Unit
Forward Voltage	V _F	IF=65mA	2.58	2.87	3.16	V
Reverse Current	I _R	VR=5V	-	-	100	μA
Luminous Flux	Φ _v	IF=65mA	16.8	19.8	22.8	lm
CRI	Ra	IF=65mA	90	95	-	-
Thermal Resistance	Rj-s *1	Junction-Solder	-	40.0	-	C/W

*1 Thermal Resistance : Junction-Solder terminal

(3) Ranking (Condition : IF=65mA, Ts=25C)

Parameter	Symbol	Rank	Min.	Max.	Unit
Forward Voltage	V _F	Q	2.58	2.77	V
		R	2.77	2.97	
		S	2.97	3.16	
Luminous Flux	Φ _v	B	16.8	18.8	lm
		C	18.8	20.8	
		D	20.8	22.8	

*1 The tolerance of measurement at our tester is VF±3% , φv±7%

*For an order, products within the rank listed above will be delivered.

Except designation of a delivery proportion of each rank.

Symbol	CITILED
Name	CLL130-0101C1-28GV1J4
CITIZEN ELECTRONICS CO.,LTD. JAPAN	

DATA SHEET

4/14

Chromaticity coordinates (Condition : IF=65mA, Tc = 25C)

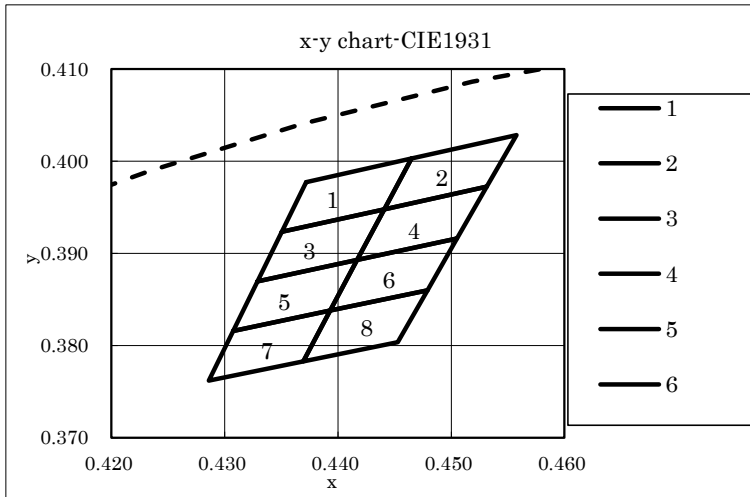

Color Rank	x	y	Color Rank	x	y
1	0.4372	0.3977	2	0.4465	0.4003
	0.4350	0.3924		0.4441	0.3948
	0.4441	0.3948		0.4531	0.3972
	0.4465	0.4003		0.4558	0.4028

Color Rank	x	y	Color Rank	x	y
3	0.4350	0.3924	4	0.4441	0.3948
	0.4329	0.3870		0.4417	0.3893
	0.4417	0.3893		0.4505	0.3916
	0.4441	0.3948		0.4531	0.3972

Color Rank	x	y	Color Rank	x	y
5	0.4329	0.3870	6	0.4417	0.3893
	0.4307	0.3816		0.4393	0.3838
	0.4393	0.3838		0.4479	0.3860
	0.4417	0.3893		0.4505	0.3916

Color Rank	x	y	Color Rank	x	y
7	0.4307	0.3816	8	0.4393	0.3838
	0.4286	0.3762		0.4369	0.3783
	0.4369	0.3783		0.4453	0.3804
	0.4393	0.3838		0.4479	0.3860

*1 The tolerance of measurement at our tester is Chromaticity(x,y)±0.01
 *For an order, products within the rank listed above will be delivered.
 Except designation of a delivery proportion of each rank.

Symbol	CITLED
Name	CLL130-0101C1-28GV1J4
CITIZEN ELECTRONICS CO.,LTD. JAPAN	

5. Characteristics

Forward Current vs. Forward Voltage

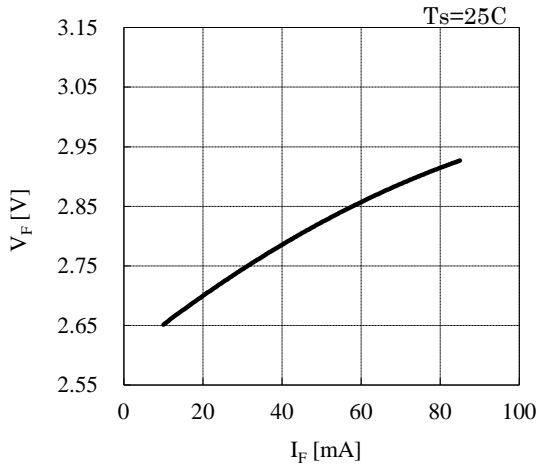

Forward Current vs. Relative Luminous Flux

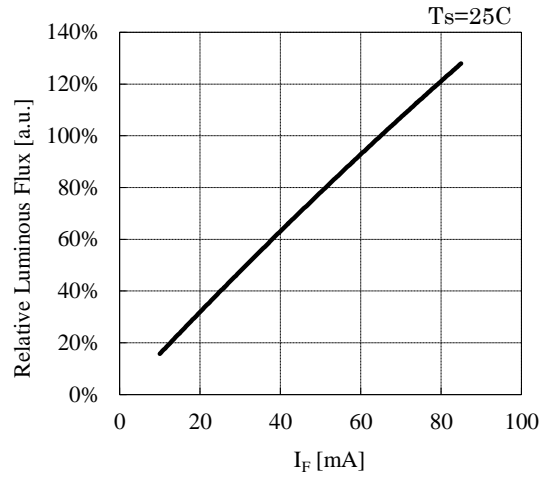

Forward Current vs. Chromaticity Coordinate

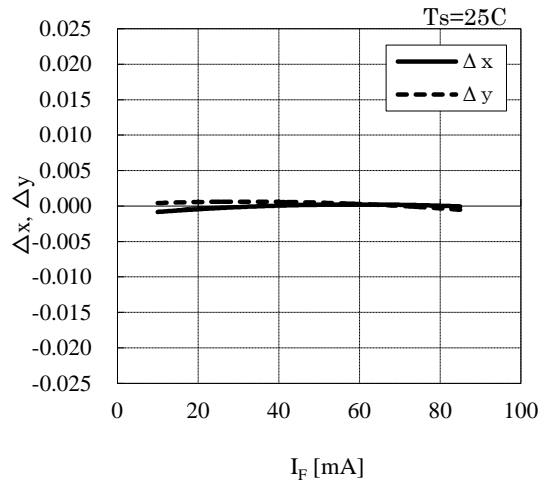

Solder Temperature vs. Chromaticity Coordinate

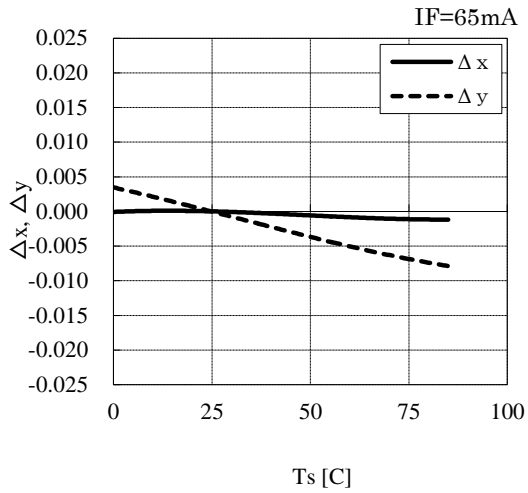

Symbol	CITLED
Name	CLL130-0101C1-28GV1J4
CITIZEN ELECTRONICS CO.,LTD. JAPAN	

DATA SHEET

6/14

Solder Temperature vs. Forward Voltage
IF=65mA

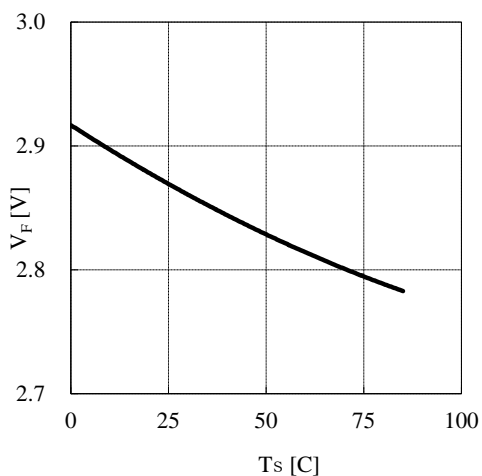

Solder Temperature vs. Relative Luminous Flux
IF=65mA

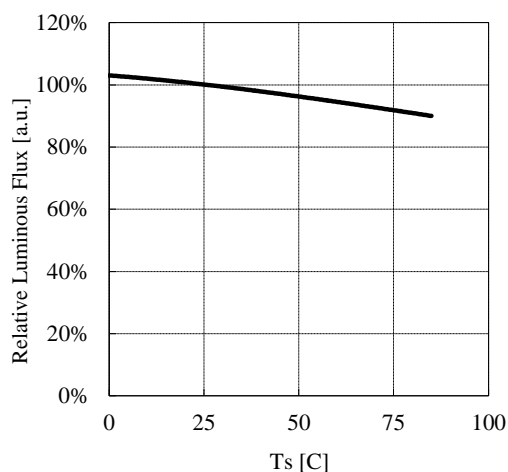

Case Temperature vs. Allowable Forward Current

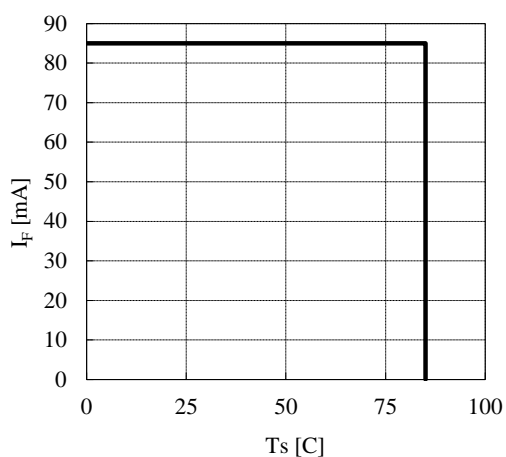

Directive Characteristic

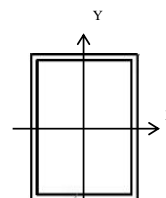
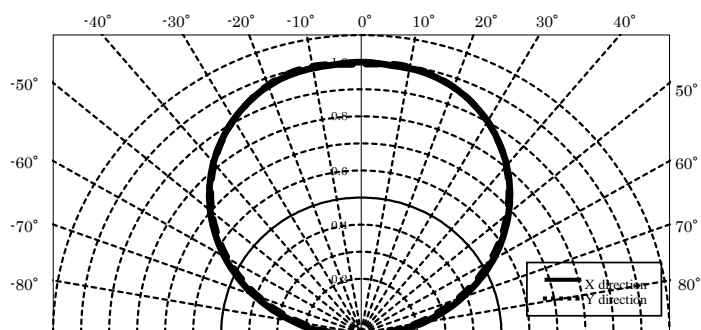

Symbol	CITILED
Name	CLL130-0101C1-28GV1J4
CITIZEN ELECTRONICS CO.,LTD. JAPAN	

DATA SHEET

7/14

6. Reliability

(1) Details of the tests

Test Item	Test Condition
Continuous Operation Test	IF=65mA Ta=25C × 1000 hours
Low Temperature Storage Test	-40 C × 1000 hours
High Temperature Storage Test	100 C × 1000 hours
Moisture-proof Test	85 C, 85 %RH for 500 hours
Thermal Shock Test	-40 C × 30 minutes – 100 C × 30 minutes, 100 cycle

(2) Judgement Criteria of Failure for Reliability Test

(Ta=25C)

Measuring Item	Symbol	Measuring Condition	Judgement Criteria for Failure
Forward Voltage	VF	IF=65mA	>U X 1.1
Reverse Current	IR	VF=5V	> U×2
Total Luminous Flux	Φv	IF=65mA	<S X 0.7

U defines the upper limit of the specified characteristics. S defines the initial value.

Note : Measurement shall be taken between 2 hours and 24 hours, and the test pieces should be return to the normal ambient conditions after the completion of each test.

Symbol	CITLED
Name	CLL130-0101C1-28GV1J4
CITIZEN ELECTRONICS CO.,LTD. JAPAN	

7. Taping Specifications (in accordance with JIS standard)

(1) Shape and Dimensions of Reel

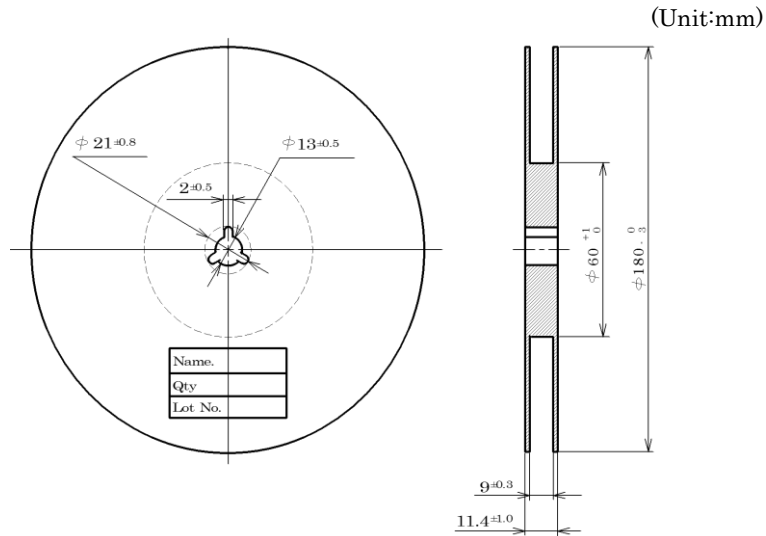

(2) Dimensions of Tape

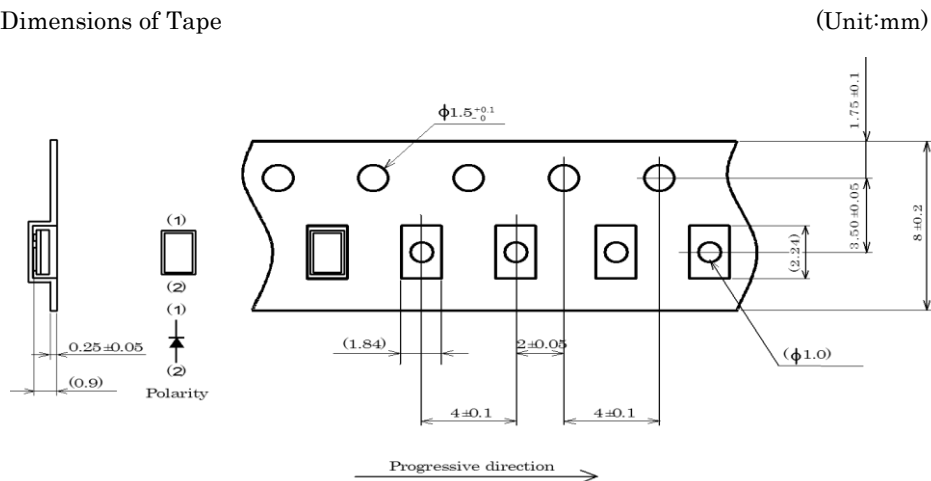

(3) Configuration of Tape

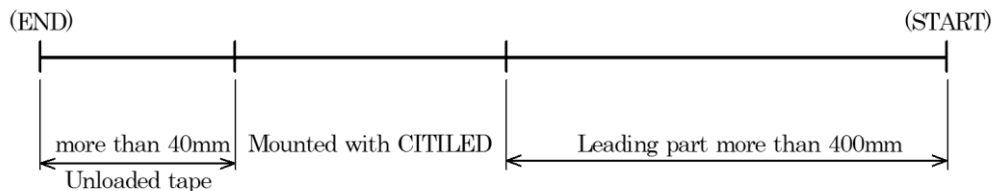

(4) Quantity : 3000pcs/reel

※A standard quantity is 3000 pieces/reel and a minimum quantity is 1000 pcs/reel

Symbol	CITILED
Name	CLL130-0101C1-28GV1J4
CITIZEN ELECTRONICS CO.,LTD. JAPAN	

8.Soldering

8-1, Lead free soldering

(1) Following soldering paste is recommended

Melting temperature : 216 ~ 220C.

Composition : Sn 3.5Ag 0.75Cu

(2) The temperature profile at the top surface of the parts is recommended as shown below.

(3) It is requested that products should be handled after their temperature has dropped down to the normal room temperature

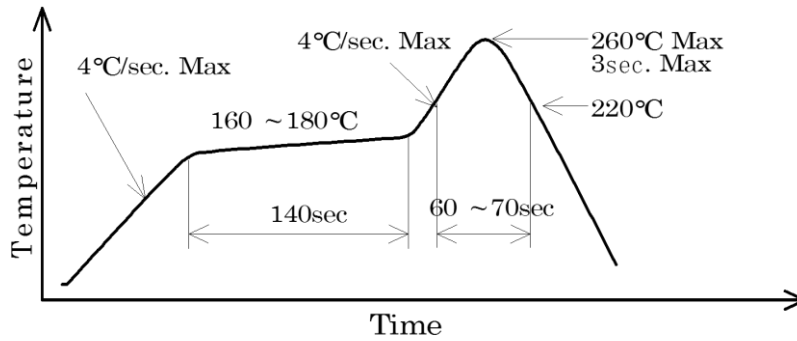

8-2 Recommended soldering pattern

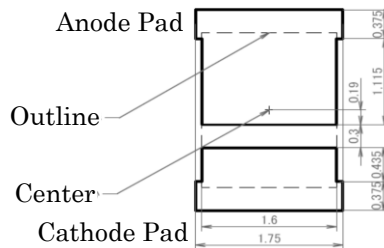

Mountability and solderability need to be optimized with actual conditions such as amount of solder, reflow temperature applied in the process.

8-3. Recommended pickup nozzle

- Shape : Circular
- Dimension : Diameter more than 1.5mm

8-4. Washing

(1) When washing after soldering is needed, following conditions are requested.

- a) Washing solvent: Pure Water
- b) Temperature, time: 50C or less × 30 seconds max or 30C or less × 3 minutes max.

Symbol	CITILED
Name	CLL130-0101C1-28GV1J4
CITIZEN ELECTRONICS CO.,LTD. JAPAN	

9. Packing Specifications

9-1. Moisture-proof Packing

To prevent moisture absorption during transportation and storage, reels are packed in aluminum envelopes

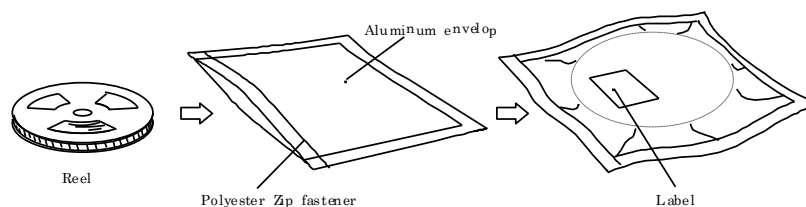

9-2. Storage

To prevent moisture absorption, it is strongly recommended that reels (in bulk or taped) should be stored in the dry box (or the desiccator) with a desiccant as the appropriate storage place. If not, the following is recommended.

Temperature : 5~30C
 Humidity : 60%RH max.

The devices should be mounted as soon as possible after unpacking. If you store the unpacked reels, please store them in the dry box or seal them into the envelop again.

Moisture Sensitive Level 1. (IPC/JEDEC J-STD-020C)

Storage limitation : Before Unpacked Aluminium envelop : 1 year from delivered day.
 After Unpacked Aluminium envelop : 168H

Symbol	CITLED
Name	CLL130-0101C1-28GV1J4
CITIZEN ELECTRONICS CO.,LTD. JAPAN	

10. Precautions

(1) Handling with care for this product

- When assembling the circuit board into the finished products, care must be taken to avoid the component parts from touching other parts.
- Please avoid the resin area from being pressed, stressed, rubbed, come into contact with sharp metal nail (e.g. edge of reflector part) because the function, performance and reliability of this product are negatively impacted.

(2) Countermeasure against static electricity

- Handling of this product needs countermeasures against static electricity because this is a semiconductor product.
- Please take adequate measures to prevent any static electricity being produced such as the wearing of a wristband or anti-static gloves when handling this product.
- Every manufacturing facility in regard to the product (plant, equipment, machine, carrier machine and conveyance unit) should be connected to ground and please avoid the product to be electric-charged.
- After assembling the LEDs into your final product(s), it is recommended to check whether the assembled LEDs are damaged by static electricity (electrical leak phenomenon) or not.
- It is easy to find static damaged LED dies by a light-on test with the minimum current value.

(3) Thermal Design

- The thermal design to draw heat away from the LED junction is most critical parameter for an LED illumination system. High operating temperatures at the LED junction adversely affect the performance of LED's light output and lifetime. Therefore the LED junction temperature should not exceed the absolute maximum rating in LED illumination system.
- The LED junction temperature while operation of LED illumination system depends upon thermal resistance of internal LED package (Rj-c), outer thermal resistances of LED package, power loss and ambient temperature. Please take both of the thermal design specifications and ambient temperature conditions into consideration for the setting of driving conditions.
- For more information, please refer to application note "Thermal Management".

(4) Driving Current

- A constant current is recommended as an applying driving current to this product. In the case of constant voltage driving, please connect current-limiting resistor to each products in series and control the driving current to keep under the absolute maximum rating forward current value.
- Electrical transient might apply excess voltage, excess current and reverse voltage to the product(s). They also affect negative impact on the product(s) therefore please make sure that no excess voltage, excess current and reverse voltage is applied to the product(s) when the LED driver is turn-on and/or turn-off.
- For more information, please refer to application note "Driving".

Symbol	CITILED
Name	CLL130-0101C1-28GV1J4
CITIZEN ELECTRONICS CO.,LTD. JAPAN	

10. Precautions (continued)

(5) Lighting at a minimum current value

-In a case where the minimum current(I_{F min}) is applied to the product, some of LED dice in the product might look different in their brightness due to the individual difference of the LED dice, and they are not failed.

(6) Eye Safety

- The International Electrical Commission (IEC) published in 2006 IEC 62471 "2006 Photobiological safety of lamps and lamp systems " which includes LEDs within its scope.
- When sorting single LEDs according to IEC 62471, almost all white LEDs can be classified as belonging to either Exempt Group (no hazard) or Risk Group 1 (low risk).
- However, Optical characteristics of LEDs such as radiant flux, spectrum and light distribution are factors that affect the risk group determination of the LED, and especially a high-power LED, that emits light containing blue wavelengths, might have properties equivalent to those of Risk Group 2 (moderate risk).
- Great care should be taken when directly viewing an LED that is driven at high current, has multiple uses as a module or when focusing the light with optical instruments, as these actions might greatly increase the hazard to your eyes.
- It is recommended to regard the evaluation of stand-alone LED packages as a reference and to evaluate your final product.

(7) Usage Condition

- This product is not designed for usage under the following conditions. If the product might be used under the following conditions, you shall evaluate its effect and appropriate them. In places where the product might:
 - directly and indirectly get wet due to rain and/or at place with the fear.
 - be damage by seawater and/or at place with the fear
 - be exposed to corrosive gas (such as Cl₂, H₂S, NH₃, SO_x, NO_x and so on) and/or at place with the fear.
 - be exposed to dust, fluid or oil and/or at place with the fear.
- It is requested to avoid applying any stress to the resin portion of this product.

Symbol	CITILED
Name	CLL130-0101C1-28GV1J4
CITIZEN ELECTRONICS CO.,LTD. JAPAN	

11. Precautions with regard to product use

- (1) This document is provided for reference purposes only so that CITIZEN ELECTRONICS' products are used as intended. CITIZEN ELECTRONICS neither makes warranties or representations with respect to the accuracy or completeness of the information contained in this document nor grants any license to any intellectual property rights or any other rights of CITIZEN ELECTRONICS or any third party with respect to the information in this document.
- (2) All information included in this document such as product data, diagrams, charts, is current as of the date this document is issued.
Such information, however, is subject to change without any prior notice.
Before purchasing or using any CITIZEN ELECTRONICS' products listed in this document, please confirm the latest product information with a CITIZEN ELECTRONICS' sales office, and formal specifications must be exchanged and signed by both parties prior to mass production.
- (3) CITIZEN ELECTRONICS has used reasonable care in compiling the information included in this document, but CITIZEN ELECTRONICS assumes no liability whatsoever for any damages incurred as a result of errors or omissions in the information included in this document.
- (4) Absent a written signed agreement, except as provided in the relevant terms and conditions of sale for product, and to the maximum extent allowable by law, CITIZEN ELECTRONICS assumes no liability whatsoever, including without limitation, indirect, consequential, special, or incidental damages or loss, including without limitation, loss of profits, loss of opportunities, business interruption and loss of data, and disclaims any and all express or implied warranties and conditions related to sale, use of product, or information, including warranties or conditions of merchantability, fitness for a particular purpose, accuracy of information, or no infringement.
- (5) Though CITIZEN ELECTRONICS works continually to improve products' quality and reliability, products can malfunction or fail. Customers are responsible for complying with safety standards and for providing adequate designs and safeguards to minimize risk and avoid situations in which a malfunction or failure of a product could cause loss of human life, bodily injury or damage to property, including data loss or corruption.
In addition, customers are also responsible for determining the appropriateness of use of any information contained in this document such as application cases not only with evaluating by their own but also by the entire system.
CITIZEN ELECTRONICS assumes no liability for customers' product design or applications.
- (6) Please contact CITIZEN ELECTRONICS' sales office if you have any questions regarding the information contained in this document, or if you have any other inquiries.

CITIZEN Micro HumanTech is a registered trademark of Citizen Holding Co., Japan.
CITILED is a registered trademark of CITIZEN ELECTRONICS CO., LTD. Japan

Symbol	CITILED
Name	CLL130-0101C1-28GV1J4
CITIZEN ELECTRONICS CO.,LTD. JAPAN	

12. Delivery Style

This product is delivered with the following combinations (Opposing corner 1:1).

(1) Combinations

Combination	Chromaticity Rank	
a	1	8
b	2	7
c	3	6
d	4	5

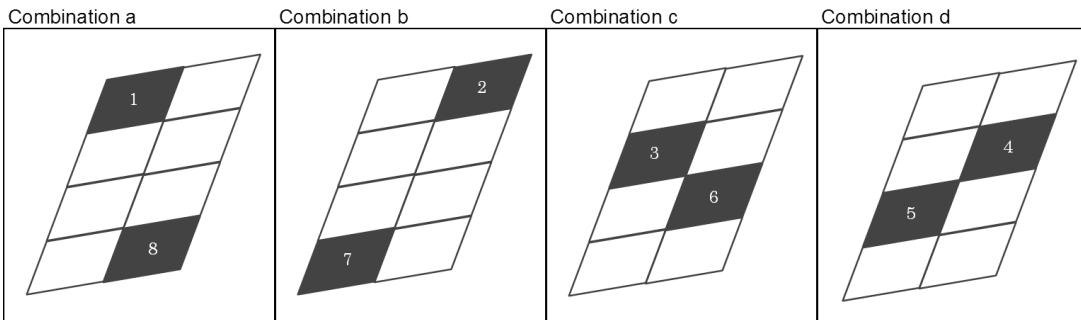

※Please be aware that we are unable to specify the delivery combination and ratio.

Symbol	CITLED
Name	CLL130-0101C1-28GV1J4
CITIZEN ELECTRONICS CO.,LTD. JAPAN	