

CITILED LCN Series
Color changing Type
DATA SHEET

LCN-C01B2



CONTENTS

1. Introduction	P 2
2. Performance Characteristics	P 3
3. Mechanical Dimensions	P 5
4. Characteristic Curves	P 6
5. Reliability	P 9
6. Packing Specification	P 10
7. Precaution	P 11
8. Precautions with regard to product use	P 14

CITIZEN ELECTRONICS CO., LTD.

1-23-1, Kamikurechi, Fujiyoshida-shi, Yamanashi, 403-0001, Japan Tel. +81-555-23-4121 <http://ce.citizen.co.jp>
Copyright © 2010 CITIZEN ELECTRONICS CO., LTD. All Rights reserved.

Product Nomenclature

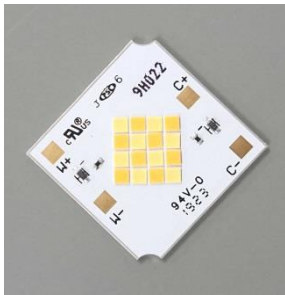

	LCN	-	C	01	B2
	[1]		[2]	[3]	[4]
[1]	Product shape			LCN	
[2]	Mount Type		C : Cluster		
[3]	Lm category		01: 1,000lm		
[4]	Version		Internal code		
	Cool white color		6,500K		
	Warm white color		2,700K		

This product (LCN) is comprised of two different CCTs, and is to be driven using the 4 terminals which are shown in Page 5.

- Mechanical Dimensions : 20.0 x 20.0 x 1.7 (mm)
- Package Structure : Aluminium Base Chip on Board
- Aluminum Base: : Aluminum PWB
- Connection to Heat Sink : M3 screw, using thermally conductive glue is recommended
- CRI (Ra) : Min.80
- Cool white color : 6,500K (IF=350mA)
- Warm white color : 2,700K (IF=350mA)
- Chromaticity Range : 3-step (2700K) & 5-step (6500K) Ellipse
- Thermal Resistance : 3.5 C/W
- RoHS compliant

2. Performance Characteristics

2-1. Electro Optical Characteristics

(Tc=25C)

Product cord	Nominal CCT	CRI (Ra)		Luminous flux (lm)			Chromaticity		Forward Current (mA)	Voltage (V)			Thermal Resistance Rj-c (C/W)
		Ra	R9	Min.	Typ.	Max.	x	y		Min.	Typ.	Max.	
		Min	Min				Typ	Typ					
LCN-C01B2	2700K	80	0	938	1,078	-	0.4543	0.4076	350.0	21.6	24.0	26.4	3.5
	6500K	80	0	1,048	1,205	-	0.3111	0.3241	350.0	21.6	24.0	26.4	3.5

Notes :

1. The tolerance of measurement at our tester is VF+/-3% , Φv+/-10% , Chromaticity(x,y)+/-0.01 and Ra+/-2.

2-2. Absolute Maximum Ratings

Parameter	Symbol	Rating	
Input Power [W]	Pi	10.6	*1*4
Forward Current [mA]	IF	400.0	*1
Reverse Voltage [V]	Vr	3	
Operating Temperature [C]	Top	-30 ~ +100	*5
Storage Temperature [C]	Tst	-40 ~ +100	
Case Temperature [C]	Tc	100	*2
Junction Temperature [C]	Tj	135	*3

*1. Power input and forward current are the values when the LED is used within the range of the derating characteristics in this data sheet.

*2 Refer to 3. Mechanical Dimensions for Tc measurement point

*3 $T_j = T_c + R_{j-c} \times P_i$

*4 Absolute maximum of power input and Forward current are the summation of cool color & warm color, - not for individual value of each input

*5 Tc refers to the deration curve in page 8, 4-3. Derating Characteristics when forward current input

2-3. Chromaticity Characteristics

(Tc=25C)

Color Region	Nominal CCT	Center Point (x, y)		Oval parameter		
				Major Axis a	Minor Axis b	Ellipse Rotation Angle θ
3-step ellipse	2700K	0.4543	0.4076	0.00774	0.00411	53.95

Color Region	Nominal CCT	Center Point (x, y)		Oval parameter		
				Major Axis a	Minor Axis b	Ellipse Rotation Angle θ
5-step ellipse	6500K	0.3111	0.3241	0.01115	0.00475	57.65

* θ is the angle between the major axis of the ellipse and the x-axis, and a and b are the major and minor semi-axes of an ellipse.

Color region

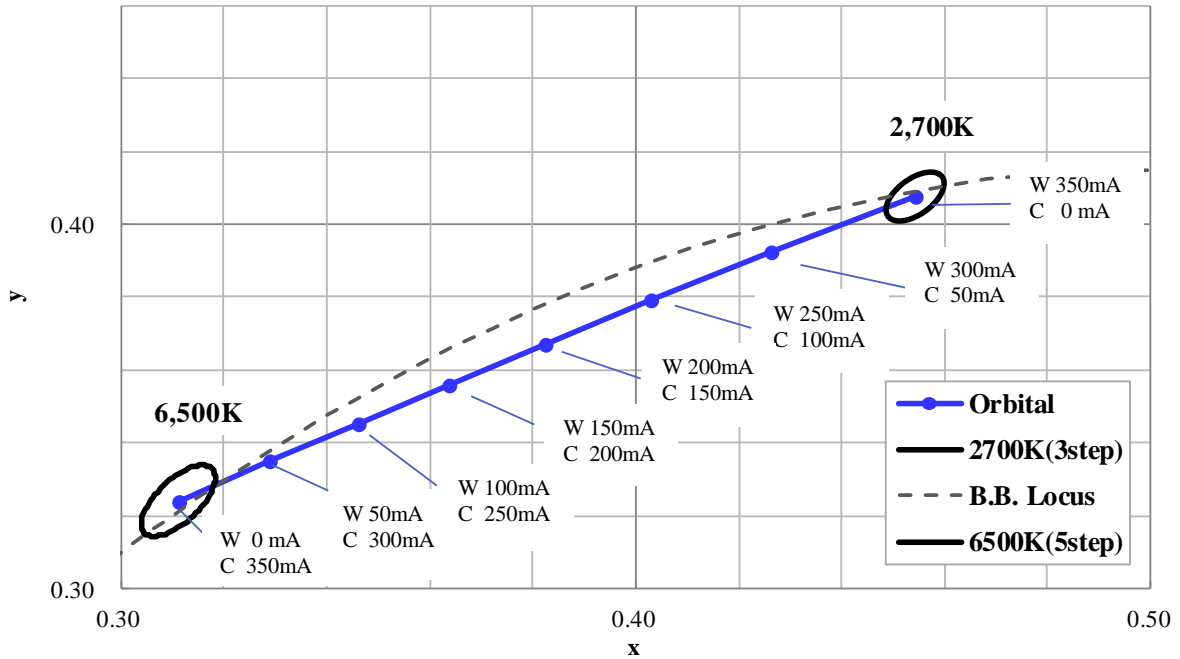

3. Mechanical Dimensions

Unit : mm

Tolerances unless otherwise specified : +/-0.3

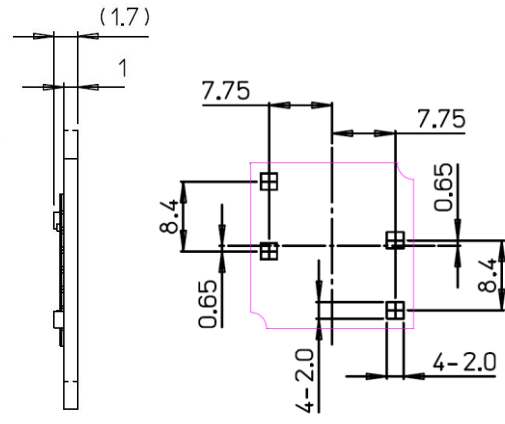
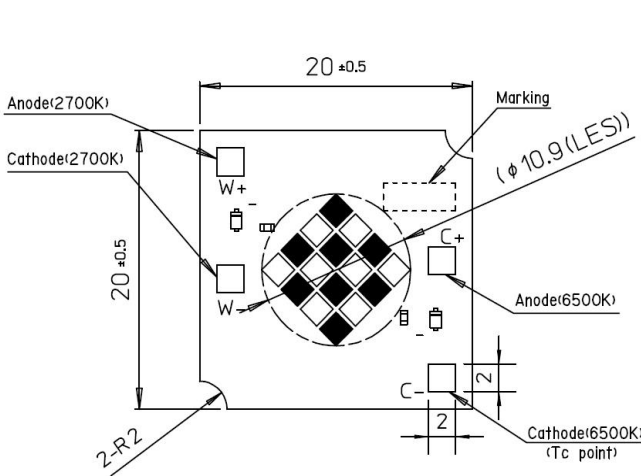

PAD position layout

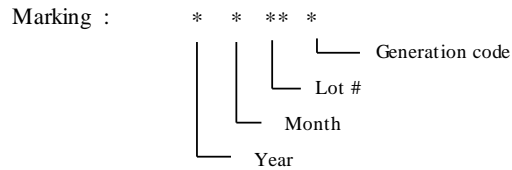

Circuit diagram

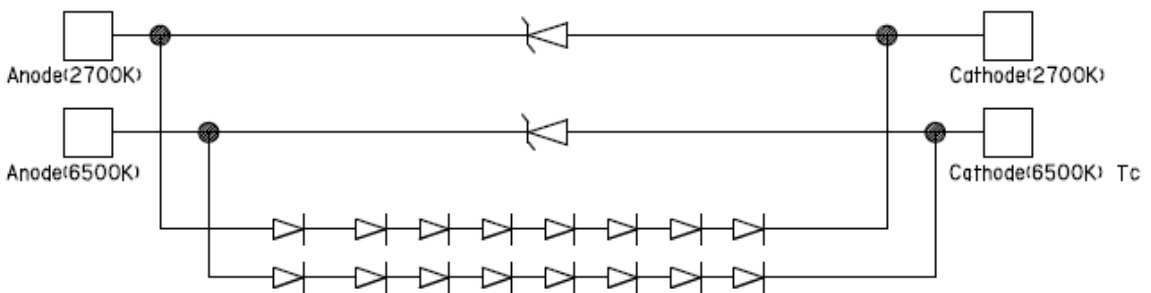

4. Characteristic Curves

4-1. Forward Current Characteristics / Temperature Characteristics

Forward current vs. Forward voltage

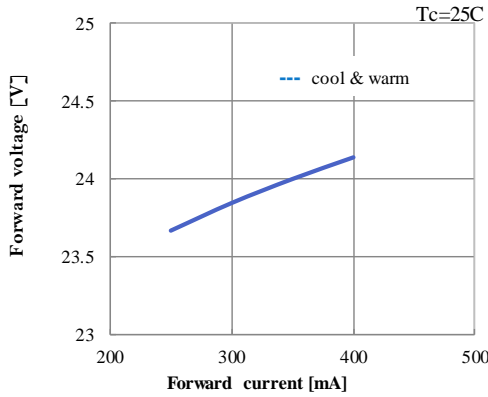

Forward Current vs. Relative Luminous flux

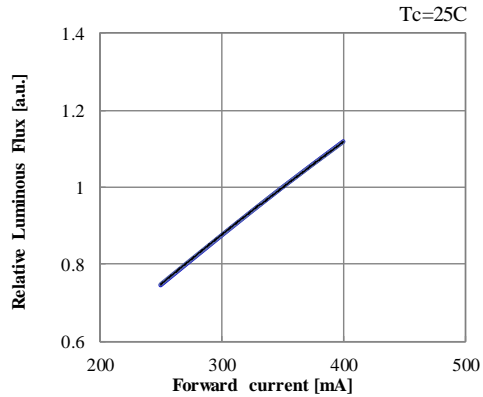

Forward current vs. xy Chromaticity

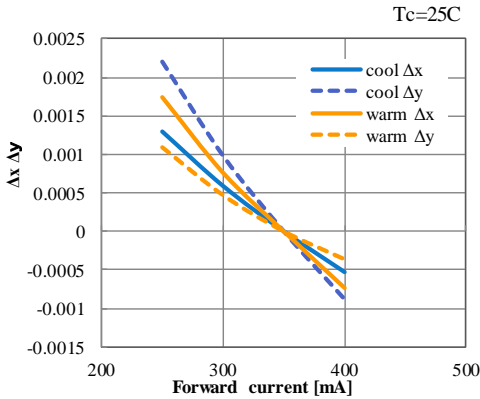

xy shifting curve & flux curve

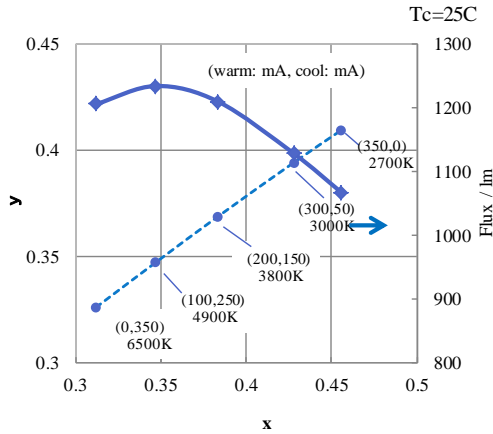

Case Temperature vs. Forward Voltage

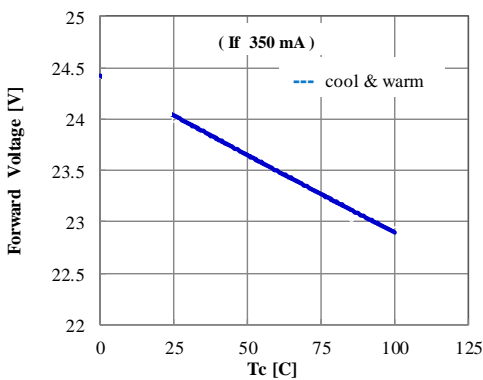

Case Temperature vs. Relative Luminous Flux

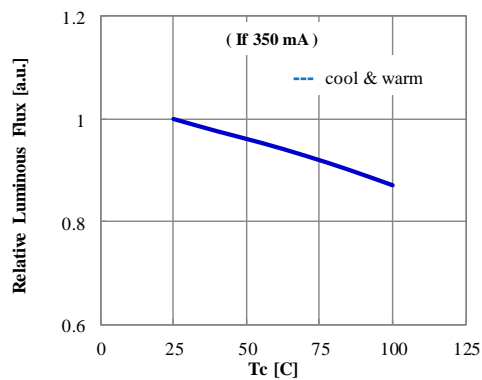

* Characteristics data shown here are for reference purpose only. (Not guaranteed data)

Copyright © 2010 CITIZEN ELECTRONICS CO., LTD. All Rights reserved.

4-2. Optical Characteristics

Spectrum

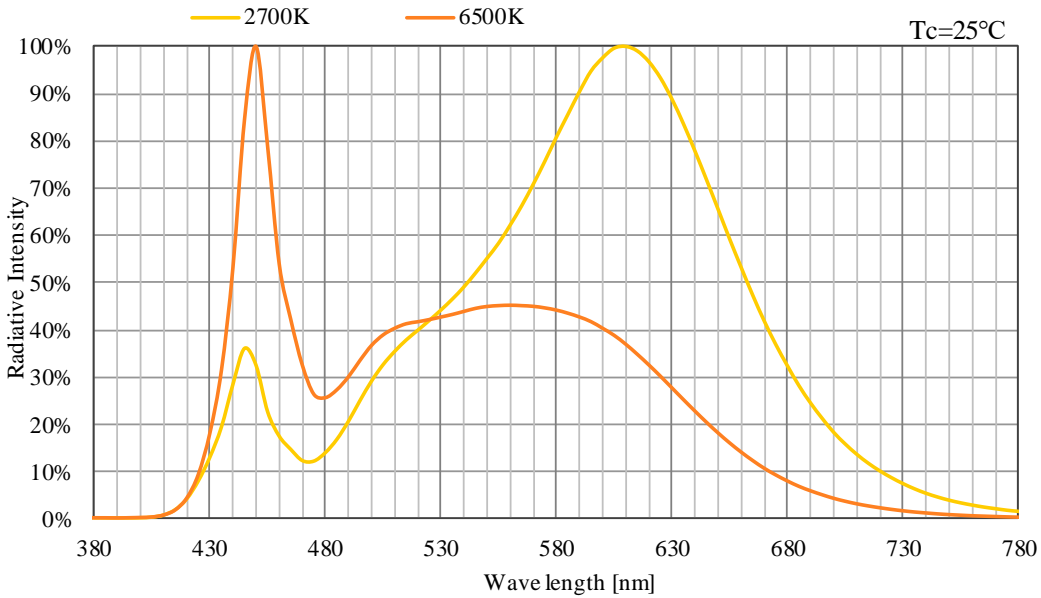

Radiation Characteristic

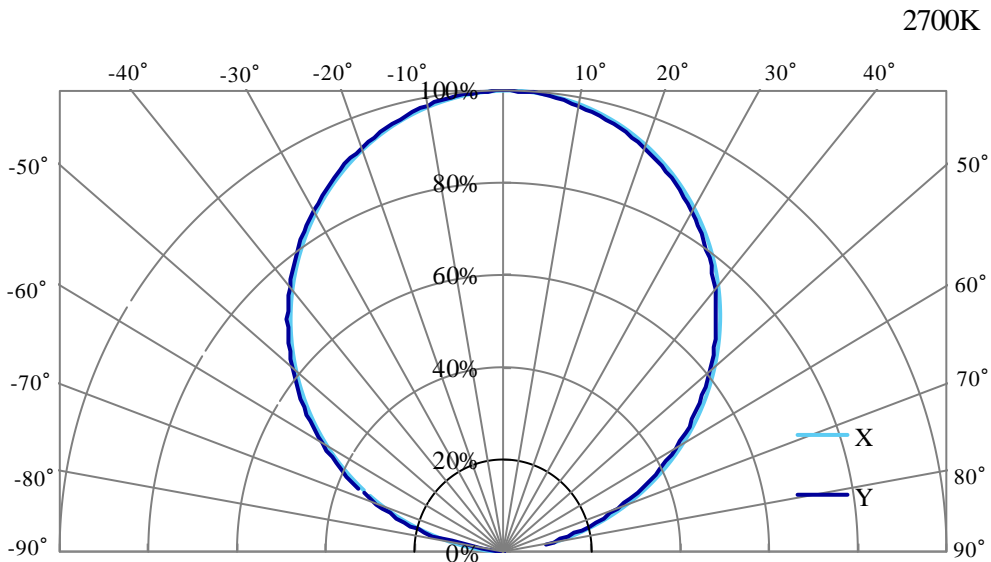

4-2. Optical Characteristics (continued)

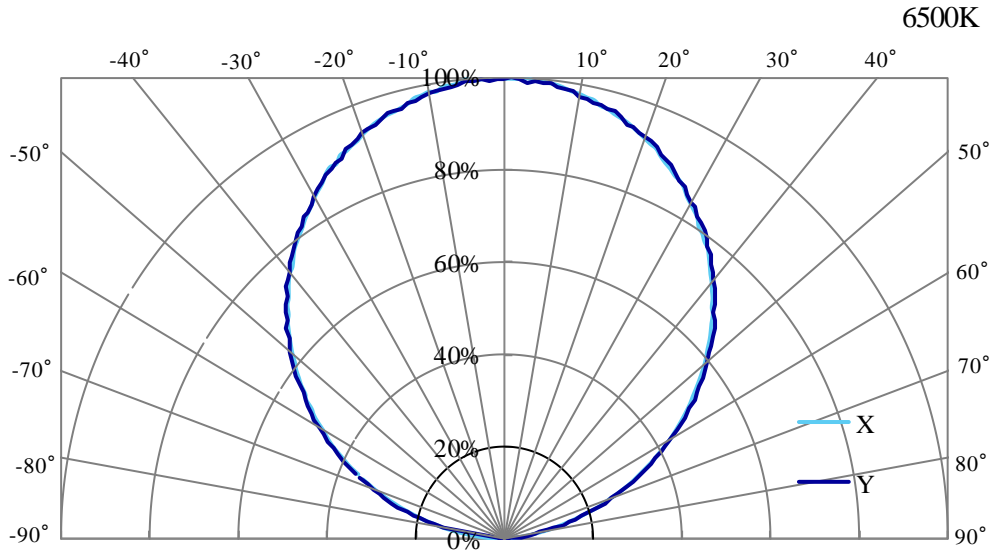

4-3. Derating Characteristics

Case Temperature vs. Allowable Forward Current

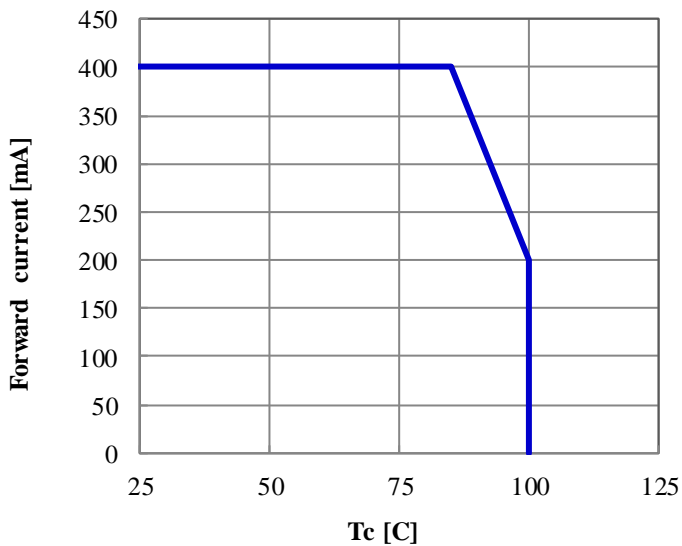

5. Reliability

5-1. Reliability Test

Test Item	Test Condition
Continuous Operation Test	IF =350mA , Tc=100 C, 1000hours
Low Temperature Storage Test	Ta = -40 C × 1000 hours
High Temperature Storage Test	Ta = 100 C × 1000 hours
Moisture-proof Test	Tc=60 C, 95 %RH for 1000 hours
Thermal Shock Test	-40 C × 30 minutes – 100 C × 30 minutes, 100 cycle

5-2. Failure Criteria

(Tc=25C)

Measuring Item	Symbol	Measuring Condition	Failure Criteria
Power Dissipation	VF	IF =350mA	>U × 1.1
Total Luminous Flux	Φv	IF =350mA	<S × 0.7

U defines the upper limit of the specified characteristics. S defines the initial value.

Note : Measurement shall be taken between 2 hours and 24 hours, and the test pieces should be return to the normal ambient conditions after the completion of each test.

6. Packing Specification

6-1. Packing

An empty tray is placed on top of a 6-tier tray which contain 30 pieces each.
(Smallest packing unit: 150 pieces)

Tray (Dimensions: 310 x 210 x 12 mm / Materials: Electrically conductive PS)

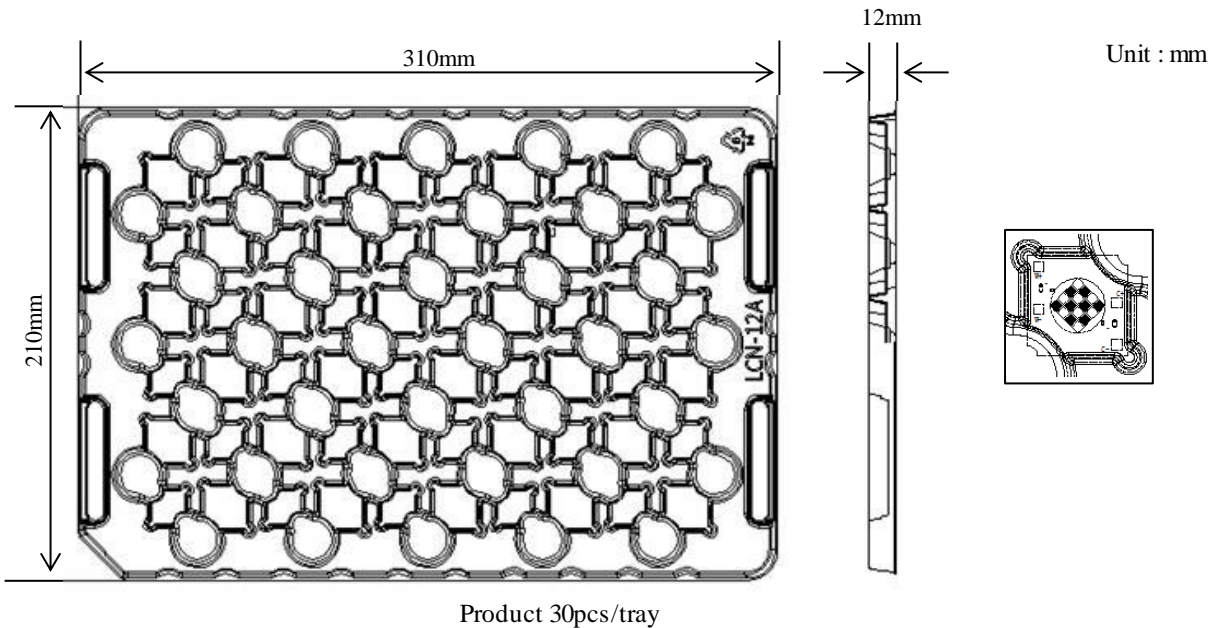

Example of indication label

CUSTOMER	
Type : LCN-*****	---(1)
P. No. : *****	---(2)
Lot No. : *****	---(3)
Date : *****	---(4)
Q'ty : ***	---(5)
CITIZEN ELECTRONICS CO., LTD.	

PASS

1. Type e.g. LCN-C01B2
2. P.No. (Customer's P/N)
3. Lot No.
 - First letter: Last digit of the year e.g. 0 : year 2020
 - Second letter: Production month
Jan.=A, Feb.=B, Mar.=C, Apr.=D, May.=E, Jun.=F
Jul.=G, Aug.=H, Sep.=J, Oct.=K, Nov.=L, Dec.=M
 - Third & forth letter: CE's control number
 - Fifth letter: Generation code=2 e.g. 0A022
4. Shipping Date
5. Quantity

7. Precaution

7-1. Handling with care for this product

-Both the light emitting area (warm & cool) is composed of resin materials.

Please avoid any pressure, stress, friction, or contact with sharp metal nail (e.g. edge of reflector part) added to the resin area because the function, performance and reliability of the product are negatively impacted.

-Please be aware that this product should not come into contact with any other parts while incorporating in your lighting apparatus or your other products.

-Please be aware that careful handling is required after the attachment of lead wires to prevent the application of any load to the connections.

7-2. Countermeasure against static electricity

- Handling of this product needs countermeasures against static electricity because this is a semiconductor product.

- Please take adequate measures to prevent any static electricity being produced such as by wearing of a wristband or anti-static gloves when handling this product.

- Every manufacturing facility in regard to the product (plant, equipment, machine, carrier machine and conveyance unit) should be grounded to prevent the product from being electric-charged.

- ESD sensitivity of this product is over 1000V (HBM, based on JEITA ED-4701/304).

- After assembling the modules into your final product(s), it is recommended to check whether the assembled modules are damaged by static electricity (electrical leak phenomenon) or not.

- It is easy to find damaged LED dies by a light-on test with the minimum current value.

7-3. Caution of product assembly

-Regarding this product assembling on the heat sink, it is recommended to use M3 screw & to use thermal conductivity glue or grease, and please optimize the assembly conditions according to the specifications of the thermal conductivity glue or grease

It might be good for screw tightening on the heat sink to do temporary tightening and final tightening.

In addition, please don't press with excess stress on the product while the assembly. And, the surfaces of thermal conductivity glue or grease, should be kept clean, therefore please remove pollution, fluid and oil on the surfaces.

-The condition of the product assembling on the heat sink and the control of screw tightening torque needs to be optimized according to the specification of the heat sink.

-Roughness, unevenness and burr of surface negatively impact thermal bonding between the product and heat sink and increase heat thermal resistance between them.

Confidence of thermally and mechanical coupling between the product and heat sink are confirmed by checking the mounting surface and measuring the case temperature of the product.

-In order to reduce the thermal resistance at assembly, it might be good to use TIM (Thermal Interface Material) on whole contact surface of the product.

In case of using thermal grease for the TIM, it might be good to apply uniformly on the contact surface of the product.

In case of using thermal sheet for the TIM, it might be good to make sure that the product is NOT strained by stress when the screws are tightened for assembly.

- Store the product with packing in the ambient temperature of 5-30 degree C, with humidity of 20-60%, Recommended storage period is three months. If you use the product after the storage period of three months, please check electrical connectivity before use.

- Do not use the product as a lighting device or an indicating light for an emergency exit.

7-4. Thermal Design

-The thermal design to draw heat away from the LED junction is a most critical parameter for an LED illumination system. High operating temperatures at the LED junction adversely affect the performance of LED's light output and service life. Therefore, the "Tc" temperature should not exceed the absolute maximum rating (100) degrees C in your LED illumination system.

-The LED junction temperature while operation of LED illumination system depends upon thermal resistance of internal LED package (Rj-c), outer thermal resistances of LED package, power loss and ambient temperature. Please take both of the thermal design specifications and ambient temperature conditions into consideration for the setting of driving conditions.

-For more information, please refer to application note "Thermal Management".

7-5. Driving Current

- A constant current is required as an applying driving current to this product.

In case of constant voltage driving, please connect current-limiting resistor to each LED line and keep the driving current below the absolute maximum rating forward current value.

- Electrical transient might apply excess voltage, excess current and reverse voltage to the product(s), which have negative impact on the product(s). Thus, please make sure that no excess voltage, excess current or reverse voltage are applied to the product(s).

7-6. Lighting at a minimum current value

- When the minimum current(IF min) is applied to the product, some LED dice might look different in their brightness due to the individual difference of the LED dice, but they are not failed.

7-7. Electrical Safety

- This product is designed and produced according to IEC 62031:2008

(IEC 62031:2008 LED modules for general lighting. Safety specification)

- Dielectric voltage withstand test has been conducted on this product to see any failure after applying voltage between active pads and aluminum section of the product, and it is confirmed to pass at least 500V.

- Almost all items of conformity assessment for IEC62031:2008 depend upon your final product of LED illumination system.

Therefore, please assess the conformity by confirming the electrical safety of your final product.

This product complies with the criteria of IEC62031:2008.

- This product itself is designed to cover UL requirements that may be applied to a final product.

However, the UL certification needs to be granted for a final product, and it depends on the design structure, materials used and how the LED is placed and fixed in the final product.

Therefore please confirm electrical safety and dielectric in your final product.

- Component failures can be caused by excessive voltage.

- Discharge before handling this product.

7-8. Recommended soldering Condition (This product is not adaptable to reflow process.)

-For manual soldering

Please use lead-free soldering. Soldering shall be implemented using a soldering bit at a temperature lower than 350C, and shall be finished within 3.5 seconds for one land.

No external force shall be applied to resin part while soldering is implemented.

Next process of soldering should be carried out after the product has return to ambient temperature.

-For soldering correction

Regarding soldering correction, above conditions shall be applied.

Contacts number of soldering bit should be within twice for each terminal as a correction.

* Citizen Electronics cannot guarantee if usage exceeds these recommended conditions.

Please use it after sufficient verification is carried out on your own risk if absolutely necessary.

7-9. Eye Safety

- The International Electrical Commission (IEC) published in 2006 IEC 62471

”2006 Photobiological safety of lamps and lamp systems ” covers LEDs for lighting.

When sorting single LEDs according to IEC 62471, almost all white LEDs are classified as either Exempt Group (no hazard) or Risk Group 1 (low risk).

- However, optical characteristics of LEDs, such as radiant flux, spectrum and light distribution are factors that influence classification of the risk groups of the LED, and especially high-power LEDs that emit light containing blue wavelengths might have properties equivalent to those of Risk Group 2 (moderate risk).

- Great care should be taken when directly looking at LEDs that are driven at high current, that have multiple uses as a module or when focusing the light with optical instruments, as the light might damage your eyes.

- It is recommended to regard the evaluation of a LED module as a reference and to evaluate your final product.

7-10. This product is not designed for usage under the following conditions.

If the product is used or may be used in the following environment, you must take appropriate measures and evaluate its effect before use.

Places where the product is or may:

- be directly or indirectly wet with rain or splash
- be damaged by seawater or salt
- be exposed to corrosive gas (such as Cl₂, H₂S, NH₃, SO_x, NO_x, etc.)
- be exposed to dust, fluid or oil
- be placed in the enclosed space with halogenated substance and/or gas (such as Br, Cl, etc.)

8. Precautions with regard to product use

(1) This document is provided for reference purposes only so that CITIZEN ELECTRONICS' products are used as intended. CITIZEN ELECTRONICS neither makes warranties or representations with respect to the accuracy or completeness of the information contained in this document nor grants any license to any intellectual property rights or any other rights of CITIZEN ELECTRONICS or any third party with respect to the information in this document. Formal specifications must be exchanged and signed by both parties prior to mass production.

(2) All information included in this document such as product data, diagrams, charts, is current as of the date this document is issued.

Such information, however, is subject to change without any prior notice.

(3) CITIZEN ELECTRONICS has used reasonable care in compiling the information included in this document, but CITIZEN ELECTRONICS assumes no liability whatsoever for any damages incurred as a result of errors or omissions in the information included in this document.

(4) Absent a written signed agreement, except as provided in the relevant terms and conditions of sale for product, and to the maximum extent allowable by law, CITIZEN ELECTRONICS assumes no liability whatsoever, including without limitation, indirect, consequential, special, or incidental damages or loss, including without limitation, loss of profits, loss of opportunities, business interruption and loss of data, and disclaims any and all express or implied warranties and conditions related to sale, use of product, or information, including warranties or conditions of merchantability, fitness for a particular purpose, accuracy of information, or no infringement.

(5) Though CITIZEN ELECTRONICS works continually to improve products' quality and reliability, products can malfunction or fail. Customers are responsible for complying with safety standards and for providing adequate designs and safeguards to minimize risk and avoid situations in which a malfunction or failure of a product could cause loss of human life, bodily injury or damage to property, including data loss or corruption.

In addition, customers are also responsible for determining the appropriateness of use of any information contained in this document such as application cases not only with evaluating by their own but also by the entire system.

CITIZEN ELECTRONICS assumes no liability for customers' product design or applications.

(6) The product is intended to be used for general electronic equipment such as general lighting, home appliances, and information-communication equipment.

It is not designed or manufactured to be used for special application (e.g. automobiles, trains, ships, airplanes, spaceships, submarine repeaters, atomic energy control systems, traffic equipment, combustion equipment, life-support systems, and safety devices).

We will not guarantee any application suitability for goods like those described above that require special quality and reliability.

In cases where the product is used in special applications and it causes extensive property damage, threatens human life or damages the human body, we will not be held liable.

The product is not in conformity to ISO/TS16949 (IATF16949) or intended to be used for in-vehicle application.

(7) Do not reverse-engineer the product including disassemble or analyze without our approval.

(8) Please contact CITIZEN ELECTRONICS' sales office if you have any questions regarding the information contained in this document, or if you have any other inquiries.

CITILED is a registered trademark of CITIZEN ELECTRONICS CO., LTD. Japan

- CITIZEN ELECTRONICS CO., LTD. shall not be liable for any disadvantages or damages resulting from the use of technical information or data included in this document or the impossibility of download and use, responsibility for the cause of lawsuit or any other damages or losses.
- This technical information or data shall be provided 'as is' to users and CITIZEN ELECTRONICS CO., LTD. does not guarantee the absence of error or other defects in this technical information or data, conformance of this technical information or data to specific purpose, this technical information or data or its use will not infringe the rights of users or third parties or any other content.
- CITIZEN ELECTRONICS CO., LTD. reserves the right to make changes to technical information or data without notification.

Information contained in this document such as sentences, photographs and images is subject to copyright, and is protected by law. Unless it is for "duplication for private use" or "quotation" under copyright law, any duplication or diversion of this information without permission of CITIZEN ELECTRONICS CO., LTD. is prohibited by law.

CITILED is a trademark or a registered trademark of CITIZEN ELECTRONICS CO., LTD. JAPAN.

CITIZEN ELECTRONICS CO., LTD.

1-23-1, Kamikurechi, Fujiyoshida-shi, Yamanashi, 403-0001, Japan
Tel. +81-555-23-4121
<http://ce.citizen.co.jp>

Requests / Inquiries

inquiry@ce.citizen.co.jp

Website for LEDs for lighting

http://ce.citizen.co.jp/lighting_led/jp/